



Programmable Controller

MELSEC iQ-R
series

MELSEC iQ-R CANopen Module User's Manual (Startup)

-RJ71CN91



SAFETY PRECAUTIONS

(Read these precautions before using this product.)

Before using this product, please read this manual and the relevant manuals carefully and pay full attention to safety to handle the product correctly.

The precautions given in this manual are concerned with this product only. For the safety precautions of the programmable controller system, refer to the MELSEC iQ-R Module Configuration Manual.

In this manual, the safety precautions are classified into two levels: "⚠ WARNING" and "⚠ CAUTION".

 WARNING	Indicates that incorrect handling may cause hazardous conditions, resulting in death or severe injury.
 CAUTION	Indicates that incorrect handling may cause hazardous conditions, resulting in minor or moderate injury or property damage.

Under some circumstances, failure to observe the precautions given under "⚠ CAUTION" may lead to serious consequences.

Observe the precautions of both levels because they are important for personal and system safety.

Make sure that the end users read this manual and then keep the manual in a safe place for future reference.

[Design Precautions]

WARNING

- Configure safety circuits external to the programmable controller to ensure that the entire system operates safely even when a fault occurs in the external power supply or the programmable controller. Failure to do so may result in an accident due to an incorrect output or malfunction.
 - (1) Emergency stop circuits, protection circuits, and protective interlock circuits for conflicting operations (such as forward/reverse rotations or upper/lower limit positioning) must be configured external to the programmable controller.
 - (2) When the programmable controller detects an abnormal condition, it stops the operation and all outputs are:
 - Turned off if the overcurrent or overvoltage protection of the power supply module is activated.
 - Held or turned off according to the parameter setting if the self-diagnostic function of the CPU module detects an error such as a watchdog timer error.
 - (3) All outputs may be turned on if an error occurs in a part, such as an I/O control part, where the CPU module cannot detect any error. To ensure safety operation in such a case, provide a safety mechanism or a fail-safe circuit external to the programmable controller. For a fail-safe circuit example, refer to "General Safety Requirements" in the MELSEC iQ-R Module Configuration Manual.
 - (4) Outputs may remain on or off due to a failure of a component such as a relay and transistor in an output circuit. Configure an external circuit for monitoring output signals that could cause a serious accident.
 - In an output circuit, when a load current exceeding the rated current or an overcurrent caused by a load short-circuit flows for a long time, it may cause smoke and fire. To prevent this, configure an external safety circuit, such as a fuse.
 - Configure a circuit so that the programmable controller is turned on first and then the external power supply. If the external power supply is turned on first, an accident may occur due to an incorrect output or malfunction.
-

[Design Precautions]

WARNING

- For the operating status of each station after a communication failure, refer to manuals relevant to the network. Incorrect output or malfunction due to a communication failure may result in an accident.
 - When connecting an external device with a CPU module or intelligent function module to modify data of a running programmable controller, configure an interlock circuit in the program to ensure that the entire system will always operate safely. For other forms of control (such as program modification, parameter change, forced output, or operating status change) of a running programmable controller, read the relevant manuals carefully and ensure that the operation is safe before proceeding. Improper operation may damage machines or cause accidents.
 - Especially, when a remote programmable controller is controlled by an external device, immediate action cannot be taken if a problem occurs in the programmable controller due to a communication failure. To prevent this, configure an interlock circuit in the program, and determine corrective actions to be taken between the external device and CPU module in case of a communication failure.
 - Do not write any data to the "system area" and "write-protect area" of the buffer memory in the module. Also, do not use any "use prohibited" signals as an output signal from the CPU module to each module. Doing so may cause malfunction of the programmable controller system. For the "system area", "write-protect area", and the "use prohibited" signals, refer to the user's manual for the module used.
 - If a communication cable is disconnected, the network may be unstable, resulting in a communication failure of multiple stations. Configure an interlock circuit in the program to ensure that the entire system will always operate safely even if communications fail. Failure to do so may result in an accident due to an incorrect output or malfunction.
 - To maintain the safety of the programmable controller system against unauthorized access from external devices via the network, take appropriate measures. To maintain the safety against unauthorized access via the Internet, take measures such as installing a firewall.
-

[Design Precautions]

CAUTION

- Do not install the control lines or communication cables together with the main circuit lines or power cables. Keep a distance of 100mm or more between them. Failure to do so may result in malfunction due to noise.
 - During control of an inductive load such as a lamp, heater, or solenoid valve, a large current (approximately ten times greater than normal) may flow when the output is turned from off to on. Therefore, use a module that has a sufficient current rating.
 - After the CPU module is powered on or is reset, the time taken to enter the RUN status varies depending on the system configuration, parameter settings, and/or program size. Design circuits so that the entire system will always operate safely, regardless of the time.
 - Do not power off the programmable controller or reset the CPU module while the settings are being written. Doing so will make the data in the flash ROM and SD memory card undefined. The values need to be set in the buffer memory and written to the flash ROM and SD memory card again. Doing so also may cause malfunction or failure of the module.
 - When changing the operating status of the CPU module from external devices (such as the remote RUN/STOP functions), select "Do Not Open by Program" for "Opening Method" of "Module Parameter". If "Open by Program" is selected, an execution of the remote STOP function causes the communication line to close. Consequently, the CPU module cannot reopen the line, and external devices cannot execute the remote RUN function.
-

[Installation Precautions]

WARNING

- Shut off the external power supply (all phases) used in the system before mounting or removing the module. Failure to do so may result in electric shock or cause the module to fail or malfunction.
-

[Installation Precautions]

CAUTION

- Use the programmable controller in an environment that meets the general specifications in the Safety Guidelines included with the base unit. Failure to do so may result in electric shock, fire, malfunction, or damage to or deterioration of the product.
 - To mount a module, place the concave part(s) located at the bottom onto the guide(s) of the base unit, and push in the module until the hook(s) located at the top snaps into place. Incorrect interconnection may cause malfunction, failure, or drop of the module.
 - To mount a module with no module fixing hook, place the concave part(s) located at the bottom onto the guide(s) of the base unit, push in the module, and fix it with screw(s). Incorrect interconnection may cause malfunction, failure, or drop of the module.
 - When using the programmable controller in an environment of frequent vibrations, fix the module with a screw.
 - Tighten the screws within the specified torque range. Undertightening can cause drop of the screw, short circuit, or malfunction. Overtightening can damage the screw and/or module, resulting in drop, short circuit, or malfunction.
 - When using an extension cable, connect it to the extension cable connector of the base unit securely. Check the connection for looseness. Poor contact may cause malfunction.
 - When using an SD memory card, fully insert it into the SD memory card slot. Check that it is inserted completely. Poor contact may cause malfunction.
 - Securely insert an extended SRAM cassette into the cassette connector of the CPU module. After insertion, close the cassette cover and check that the cassette is inserted completely. Poor contact may cause malfunction.
 - Do not directly touch any conductive parts and electronic components of the module, SD memory card, extended SRAM cassette, or connector. Doing so can cause malfunction or failure of the module.
-

[Wiring Precautions]

WARNING

- Shut off the external power supply (all phases) used in the system before installation and wiring. Failure to do so may result in electric shock or cause the module to fail or malfunction.
 - After installation and wiring, attach a blank cover module (RG60) to each empty slot and an included extension connector protective cover to the unused extension cable connector before powering on the system for operation. Failure to do so may result in electric shock.
-

[Wiring Precautions]

CAUTION

- Individually ground the FG and LG terminals of the programmable controller with a ground resistance of 100 ohms or less. Failure to do so may result in electric shock or malfunction.
 - Use applicable solderless terminals and tighten them within the specified torque range. If any spade solderless terminal is used, it may be disconnected when the terminal screw comes loose, resulting in failure.
 - Check the rated voltage and signal layout before wiring to the module, and connect the cables correctly. Connecting a power supply with a different voltage rating or incorrect wiring may cause fire or failure.
 - Connectors for external devices must be crimped or pressed with the tool specified by the manufacturer, or must be correctly soldered. Incomplete connections may cause short circuit, fire, or malfunction.
 - Securely connect the connector to the module. Poor contact may cause malfunction.
 - Do not install the control lines or communication cables together with the main circuit lines or power cables. Keep a distance of 100mm or more between them. Failure to do so may result in malfunction due to noise.
 - Place the cables in a duct or clamp them. If not, dangling cable may swing or inadvertently be pulled, resulting in damage to the module or cables or malfunction due to poor contact. Do not clamp the extension cables with the jacket stripped. Doing so may change the characteristics of the cables, resulting in malfunction.
 - Check the interface type and correctly connect the cable. Incorrect wiring (connecting the cable to an incorrect interface) may cause failure of the module and external device.
 - Tighten the terminal screws or connector screws within the specified torque range. Undertightening can cause drop of the screw, short circuit, fire, or malfunction. Overtightening can damage the screw and/or module, resulting in drop, short circuit, fire, or malfunction.
 - When disconnecting the cable from the module, do not pull the cable by the cable part. For the cable with connector, hold the connector part of the cable. For the cable connected to the terminal block, loosen the terminal screw. Pulling the cable connected to the module may result in malfunction or damage to the module or cable.
 - Prevent foreign matter such as dust or wire chips from entering the module. Such foreign matter can cause a fire, failure, or malfunction.
 - A protective film is attached to the top of the module to prevent foreign matter, such as wire chips, from entering the module during wiring. Do not remove the film during wiring. Remove it for heat dissipation before system operation.
 - Programmable controllers must be installed in control panels. Connect the main power supply to the power supply module in the control panel through a relay terminal block. Wiring and replacement of a power supply module must be performed by qualified maintenance personnel with knowledge of protection against electric shock. For wiring, refer to the MELSEC iQ-R Module Configuration Manual.
 - For Ethernet cables to be used in the system, select the ones that meet the specifications in the user's manual for the module used. If not, normal data transmission is not guaranteed.
-

[Startup and Maintenance Precautions]

WARNING

- Do not touch any terminal while power is on. Doing so will cause electric shock or malfunction.
 - Correctly connect the battery connector. Do not charge, disassemble, heat, short-circuit, solder, or throw the battery into the fire. Also, do not expose it to liquid or strong shock. Doing so will cause the battery to produce heat, explode, ignite, or leak, resulting in injury and fire.
 - Shut off the external power supply (all phases) used in the system before cleaning the module or retightening the terminal screws, connector screws, or module fixing screws. Failure to do so may result in electric shock.
-

[Startup and Maintenance Precautions]

CAUTION

- When connecting an external device with a CPU module or intelligent function module to modify data of a running programmable controller, configure an interlock circuit in the program to ensure that the entire system will always operate safely. For other forms of control (such as program modification, parameter change, forced output, or operating status change) of a running programmable controller, read the relevant manuals carefully and ensure that the operation is safe before proceeding. Improper operation may damage machines or cause accidents.
 - Especially, when a remote programmable controller is controlled by an external device, immediate action cannot be taken if a problem occurs in the programmable controller due to a communication failure. To prevent this, configure an interlock circuit in the program, and determine corrective actions to be taken between the external device and CPU module in case of a communication failure.
 - Do not disassemble or modify the modules. Doing so may cause failure, malfunction, injury, or a fire.
 - Use any radio communication device such as a cellular phone or PHS (Personal Handy-phone System) more than 25cm away in all directions from the programmable controller. Failure to do so may cause malfunction.
 - Shut off the external power supply (all phases) used in the system before mounting or removing the module. Failure to do so may cause the module to fail or malfunction.
 - Tighten the screws within the specified torque range. Undertightening can cause drop of the component or wire, short circuit, or malfunction. Overtightening can damage the screw and/or module, resulting in drop, short circuit, or malfunction.
 - After the first use of the product, do not mount/remove the module to/from the base unit, and the terminal block to/from the module, and do not insert/remove the extended SRAM cassette to/from the CPU module more than 50 times (IEC 61131-2 compliant) respectively. Exceeding the limit may cause malfunction.
 - After the first use of the product, do not insert/remove the SD memory card to/from the CPU module more than 500 times. Exceeding the limit may cause malfunction.
 - Do not touch the metal terminals on the back side of the SD memory card. Doing so may cause malfunction or failure of the module.
 - Do not touch the integrated circuits on the circuit board of an extended SRAM cassette. Doing so may cause malfunction or failure of the module.
 - Do not drop or apply shock to the battery to be installed in the module. Doing so may damage the battery, causing the battery fluid to leak inside the battery. If the battery is dropped or any shock is applied to it, dispose of it without using.
-

[Startup and Maintenance Precautions]

CAUTION

- Startup and maintenance of a control panel must be performed by qualified maintenance personnel with knowledge of protection against electric shock. Lock the control panel so that only qualified maintenance personnel can operate it.
 - Before handling the module, touch a conducting object such as a grounded metal to discharge the static electricity from the human body. Failure to do so may cause the module to fail or malfunction.
-

[Operating Precautions]

CAUTION

- When changing data and operating status, and modifying program of the running programmable controller from an external device such as a personal computer connected to an intelligent function module, read relevant manuals carefully and ensure the safety before operation. Incorrect change or modification may cause system malfunction, damage to the machines, or accidents.
 - Do not power off the programmable controller or reset the CPU module while the setting values in the buffer memory are being written to the flash ROM in the module. Doing so will make the data in the flash ROM and SD memory card undefined. The values need to be set in the buffer memory and written to the flash ROM and SD memory card again. Doing so can cause malfunction or failure of the module.
-

[Disposal Precautions]

CAUTION

- When disposing of this product, treat it as industrial waste.
 - When disposing of batteries, separate them from other wastes according to the local regulations. For details on battery regulations in EU member states, refer to the MELSEC iQ-R Module Configuration Manual.
-

[Transportation Precautions]

CAUTION

- When transporting lithium batteries, follow the transportation regulations. For details on the regulated models, refer to the MELSEC iQ-R Module Configuration Manual.
 - The halogens (such as fluorine, chlorine, bromine, and iodine), which are contained in a fumigant used for disinfection and pest control of wood packaging materials, may cause failure of the product. Prevent the entry of fumigant residues into the product or consider other methods (such as heat treatment) instead of fumigation. The disinfection and pest control measures must be applied to unprocessed raw wood.
-

CONDITIONS OF USE FOR THE PRODUCT

(1) Mitsubishi programmable controller ("the PRODUCT") shall be used in conditions;

- i) where any problem, fault or failure occurring in the PRODUCT, if any, shall not lead to any major or serious accident; and
- ii) where the backup and fail-safe function are systematically or automatically provided outside of the PRODUCT for the case of any problem, fault or failure occurring in the PRODUCT.

(2) The PRODUCT has been designed and manufactured for the purpose of being used in general industries.

MITSUBISHI SHALL HAVE NO RESPONSIBILITY OR LIABILITY (INCLUDING, BUT NOT LIMITED TO ANY AND ALL RESPONSIBILITY OR LIABILITY BASED ON CONTRACT, WARRANTY, TORT, PRODUCT LIABILITY) FOR ANY INJURY OR DEATH TO PERSONS OR LOSS OR DAMAGE TO PROPERTY CAUSED BY the PRODUCT THAT ARE OPERATED OR USED IN APPLICATION NOT INTENDED OR EXCLUDED BY INSTRUCTIONS, PRECAUTIONS, OR WARNING CONTAINED IN MITSUBISHI'S USER, INSTRUCTION AND/OR SAFETY MANUALS, TECHNICAL BULLETINS AND GUIDELINES FOR the PRODUCT.

("Prohibited Application")

Prohibited Applications include, but not limited to, the use of the PRODUCT in;

- Nuclear Power Plants and any other power plants operated by Power companies, and/or any other cases in which the public could be affected if any problem or fault occurs in the PRODUCT.
- Railway companies or Public service purposes, and/or any other cases in which establishment of a special quality assurance system is required by the Purchaser or End User.
- Aircraft or Aerospace, Medical applications, Train equipment, transport equipment such as Elevator and Escalator, Incineration and Fuel devices, Vehicles, Manned transportation, Equipment for Recreation and Amusement, and Safety devices, handling of Nuclear or Hazardous Materials or Chemicals, Mining and Drilling, and/or other applications where there is a significant risk of injury to the public or property.

Notwithstanding the above restrictions, Mitsubishi may in its sole discretion, authorize use of the PRODUCT in one or more of the Prohibited Applications, provided that the usage of the PRODUCT is limited only for the specific applications agreed to by Mitsubishi and provided further that no special quality assurance or fail-safe, redundant or other safety features which exceed the general specifications of the PRODUCTS are required. For details, please contact the Mitsubishi representative in your region.

INTRODUCTION

Thank you for purchasing the Mitsubishi Electric MELSEC iQ-R series programmable controllers.

This manual describes the procedures, system configuration, and wiring of the relevant product listed below.

Before using this product, please read this manual and the relevant manuals carefully and develop familiarity with the functions and performance of the MELSEC iQ-R series programmable controller to handle the product correctly.

When applying the program examples provided in this manual to an actual system, ensure the applicability and confirm that it will not cause system control problems.

Please make sure that the end users read this manual.

Relevant product

RJ71CN91

COMPLIANCE WITH EMC AND LOW VOLTAGE DIRECTIVES

Method of ensuring compliance

To ensure that Mitsubishi Electric programmable controllers maintain EMC and Low Voltage Directives when incorporated into other machinery or equipment, certain measures may be necessary. Please refer to one of the following manuals.

- MELSEC iQ-R Module Configuration Manual
- Safety Guidelines (This manual is included with the base unit.)

The CE mark on the side of the programmable controller indicates compliance with EMC and Low Voltage Directives.

Additional measures

No additional measures are necessary for the compliance of this product with EMC and Low Voltage Directives.

MEMO

CONTENTS

SAFETY PRECAUTIONS	1
CONDITIONS OF USE FOR THE PRODUCT	8
INTRODUCTION	9
COMPLIANCE WITH EMC AND LOW VOLTAGE DIRECTIVES	9
RELEVANT MANUALS	12
TERMS	12
CHAPTER 1 PART NAMES	13
CHAPTER 2 SPECIFICATIONS	15
2.1 Performance Specifications	15
CHAPTER 3 FUNCTION LIST	17
CHAPTER 4 PROCEDURES BEFORE OPERATION	19
CHAPTER 5 SYSTEM CONFIGURATION	21
5.1 CANopen and CAN Network Configuration	21
5.2 Available Software Packages	22
CHAPTER 6 WIRING	23
6.1 Terminal Block	23
6.2 Wiring Methods	24
6.3 Wiring Products	25
CHAPTER 7 COMMUNICATION EXAMPLES	26
7.1 Communication Example in CANopen 405 Mode (1)	26
System configuration	26
Parameter setting	27
Program examples	34
7.2 Communication Example in CANopen 405 Mode (2)	38
System configuration	38
Parameter setting	38
Program examples	39
APPENDICES	41
Appendix 1 External Dimensions	41
Appendix 2 Software License Agreement	42
INDEX	44
REVISIONS	46
WARRANTY	47
TRADEMARKS	48

RELEVANT MANUALS

Manual name [manual number]	Description	Available form
MELSEC iQ-R CANopen Module User's Manual (Startup) [SH-081734ENG] (this manual)	Performance specifications, procedures before operation, system configuration, wiring, and communication examples of the CANopen module	Print book e-Manual PDF
MELSEC iQ-R CANopen Module User's Manual (Application) [SH-081736ENG]	Functions, parameter settings, programming, troubleshooting, I/O signals, buffer memory, and object dictionary of the CANopen module	Print book e-Manual PDF

This manual does not include detailed information on the following:

- General specifications
- Applicable combinations of CPU modules and the other modules, and the number of mountable modules
- Installation

For details, refer to the following.

 MELSEC iQ-R Module Configuration Manual

This manual does not include information on the module function blocks.

For details, refer to the Function Block Reference for the module used.

Point

e-Manual refers to the Mitsubishi Electric FA electronic book manuals that can be browsed using a dedicated tool.

e-Manual has the following features:

- Required information can be cross-searched in multiple manuals.
- Other manuals can be accessed from the links in the manual.
- The hardware specifications of each part can be found from the product figures.
- Pages that users often browse can be bookmarked.
- Sample programs can be copied to an engineering tool.

TERMS

Unless otherwise specified, this manual uses the following terms.

Term	Description
Buffer memory	Memory in an intelligent function module for storing data such as setting values and monitored values. When integrated into the CPU module, this memory refers to a memory for storing data such as setting values and monitored values of the Ethernet function, and data used for data communication of the multiple CPU system function.
CAN	The abbreviation for Controller Area Network
CANopen	CAN based higher-layer protocol
CiA	The abbreviation for CAN in Automation. Non-profit organization for standardization of CAN protocols.
CPU module	A generic term for the MELSEC iQ-R series CPU module
Device	A device (X, Y, M, D, or others) in a CPU module
Engineering tool	Another term for the software package for the MELSEC programmable controllers
Global label	A label that is valid for all the program data when multiple program data are created in the project. There are two types of global label: a module specific label (module label), which is generated automatically by GX Works3, and an optional label, which can be created for any specified device.
Intelligent function module	A module that has functions other than input and output, such as an A/D converter module and D/A converter module
Label	A label that represents a device in a given character string
Module label	A label that represents one of memory areas (I/O signals and buffer memory areas) specific to each module in a given character string. For the module used, GX Works3 automatically generates this label, which can be used as a global label.

1 PART NAMES

This chapter describes the names of each part of the RJ71CN91.

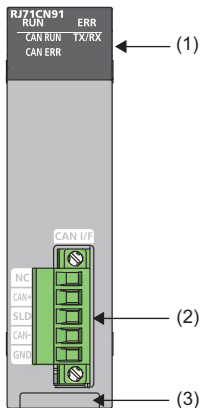

No.	Name	Description
(1)	RUN LED	Indicates the operating status. On: Normal operation Off: Error (MELSEC iQ-R CANopen Module User's Manual (Application))
	ERR LED	Indicates the error status of the module. On, flashing: Error (MELSEC iQ-R CANopen Module User's Manual (Application)) Off: Normal operation
	CAN RUN LED ^{*1}	Indicates the communication status of CANopen or CAN. For details on the communication status, refer to the following. MELSEC iQ-R CANopen Module User's Manual (Application) ■ In CANopen 405 mode On: Operational Flickering: LSS services in progress ^{*2} Blinking: Pre-operational Single flash: Stopped ■ In 11-bit CAN-ID Layer 2 message mode and 29-bit CAN-ID Layer 2 message mode On: Layer 2 online mode Off: Layer 2 offline mode
	CAN ERR LED ^{*1}	Indicates the communication error status of CANopen or CAN. For details on the communication error status, refer to the following. MELSEC iQ-R CANopen Module User's Manual (Application) On: The RJ71CN91 in the Bus OFF state Flickering: LSS services in progress ^{*2} Blinking: Setting error Double flash: A NMT guarding event or a heartbeat event has occurred. Single flash: The value of 'CAN transmission error counter' (UnG35) or 'CAN reception error counter' (UnG36) has reached the warning level. Off: Normal operation
	TX/RX LED	Indicates the sending/receiving status of CAN messages. On: CAN messages being sent or received Off: CAN messages not sent nor received
(2)	Transmission cable terminal block	A connector to connect the CAN bus cable
(3)	Production information marking	Shows the production information (16 digits) of the module.

*1 The following chart shows intervals of four flashing types (Single flash, Double flash, Blinking, and Flickering).
If the flashing LED changes, the interval may not follow. (Example: When the Single flash switch to the Double flash less than one second, flash continuously three times or more per 0.2 seconds.)

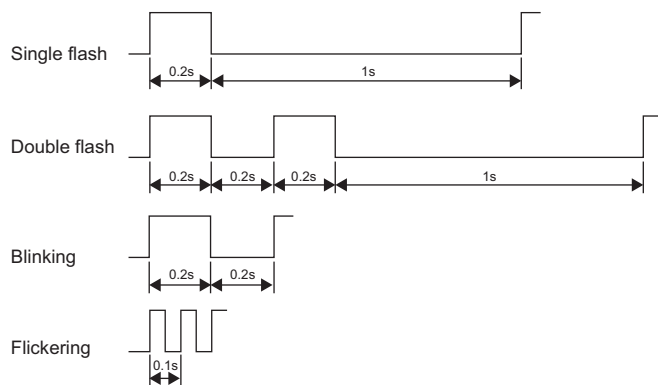

*2 The CAN RUN LED and CAN ERR LED alternately flash while the LSS services are in progress.

2 SPECIFICATIONS

2.1 Performance Specifications

This section describes the performance specifications of the RJ71CN91.

Item		Description
Transmission type		CAN bus network (RS-485, CSMA/CR)
Applicable function		<ul style="list-style-type: none"> CANopen node CAN node
CANopen communication services that are compliant with the CiA standards		<ul style="list-style-type: none"> CiA-301 V4.2 CiA-302 V4.1 CiA-305 V2.2
CANopen device/application profiles that are compliant with the CiA standards		Interface and device profile CiA-405 V2.0 for IEC 61131-3 programmable devices
Remote transmit request (RTR)		<ul style="list-style-type: none"> CANopen 405 mode: Not supported for PDO 11-bit CAN-ID Layer 2 message mode and 29-bit CAN-ID Layer 2 message mode: Supported
Amount of communication data (CANopen 405 mode)	TPDO	4 words × 256
	RPDO	4 words × 256
Frame format (11-bit CAN-ID Layer 2 message mode, 29-bit CAN-ID Layer 2 message mode)		The standard format (11-bit CAN-ID) or extended format (29-bit CAN-ID) can be selected.
Node ID		Selectable from 1 to 127
Communication method		Acyclic, cyclic, or event-driven
Baud rate		1Mbps/800kbps/500kbps/250kbps/125kbps/100kbps/50kbps/20kbps/10kbps
Maximum cable length		<ul style="list-style-type: none"> 5000m (when used at 10kbps) 2500m (when used at 20kbps) 1000m (when used at 50kbps) 600m (when used at 100kbps) 500m (when used at 125kbps) 250m (when used at 250kbps) 100m (when used at 500kbps) 50m (when used at 800kbps) 25m (when used at 1Mbps)
Connection cable		The CAN bus cable should conform to ISO 11898. (📄 Page 25 Wiring Products)
Interface		Two-piece pluggable terminal block (📄 Page 23 Terminal Block)
Number of write accesses to a flash ROM		Hundred thousand times at a maximum
Number of occupied I/O points		32
Internal current consumption (5VDC)		0.33A
External dimensions	Height	106mm (Base unit mounting side: 98mm)
	Width	27.8mm
	Depth	118.5mm
Weight		0.14kg

3 FUNCTION LIST

This chapter describes the functions of the RJ71CN91. For details on the functions, refer to the following.

📖 MELSEC iQ-R CANopen Module User's Manual (Application)

CANopen communications

Function	Description
NMT	—
	This function is used to control the CANopen network.
Node control	Controls the NMT state of the CANopen node from the NMT master.
NMT startup	When the NMT master is started up, detects NMT slaves on the CANopen network and sets parameters.
Error event control	When the NMT master detects an error in an NMT slave, controls the status of the NMT slave or network.
Boot-up control	After NMT startup, if the NMT master detects a new NMT slave, the detected NMT slave is started up.
Flying master	When the NMT master on the same network fails, its own node becomes the NMT master to continue the CANopen network control.
LSS	Sets CANopen node where node IDs and baud rate cannot be set with switches via CANopen network.
Configuration manager	Sets the NMT slave parameters when the NMT master starts up an NMT slave.
SDO	Reads from and writes to the object dictionary for any of CANopen nodes.
PDO	Transfers data in real time between multiple CANopen nodes. There are data transmission TPDO and data reception RPDO.
SYNC	Synchronizes timing of TPDO and RPDO.
TIME	Synchronizes the time between CANopen nodes on the network.
EMCY	Notifies errors found in its own node to other nodes.
Node guarding	Monitors the NMT slaves with the NMT master to detect errors of the NMT slaves.
Heartbeat	Monitors other nodes with a given CANopen node to detect errors of other nodes.
Operation setting at error occurrence	Sets an NMT state to which the RJ71CN91 is allowed to move when a communication error occurs.

CAN communications

Function	Description
Layer 2 message transmission and receive	Used to communicate data between CAN nodes.
CPU module STOP transition message	When the CPU module state moved from RUN to STOP, the RJ71CN91 sends a given data to the CAN node with a Layer 2 message.

MEMO

4 PROCEDURES BEFORE OPERATION

This chapter describes the procedures before operation.

1. Network construction

Configure the system and set the parameters which are required for start-up.

- Wiring (👉 Page 23 WIRING)
- Parameter setting (📖 MELSEC iQ-R CANopen Module User's Manual (Application))

2. Programming

Create a program. For details, refer to the following.

👉 Page 26 COMMUNICATION EXAMPLES

Point 🔑

Depending on the function mode of the module, all communications may not start if the CPU module is not in RUN state. For communication status of the module depending on CPU module operating status, refer to the following.

(📖 MELSEC iQ-R CANopen Module User's Manual (Application))

MEMO

5 SYSTEM CONFIGURATION

5.1 CANopen and CAN Network Configuration

CANopen network and CAN network consist of the RJ71CN91 (1) and node (2).

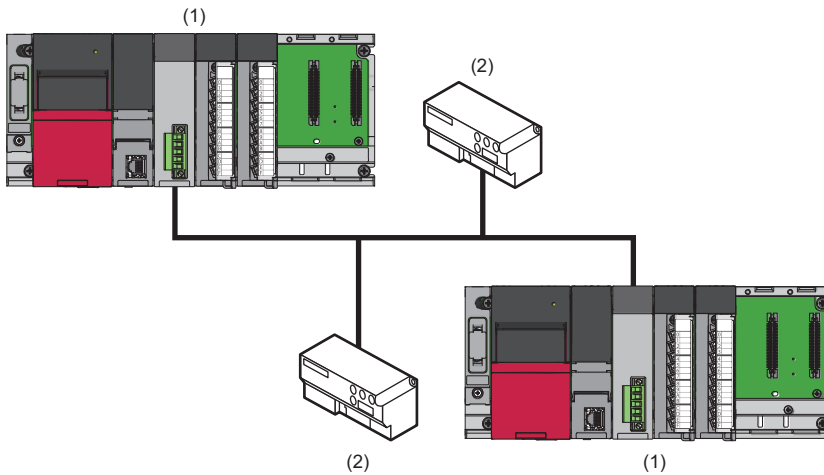

Point 

On the CANopen network, CAN node is not available. Use the CANopen node.
On the CAN network, CANopen node is not available. Use the CAN node.

5.2 Available Software Packages

GX Works3 and CANopen Configuration Tool are required for configuring the settings of the RJ71CN91.

Software	Supported version
GX Works3	Version 1.038Q or later
CANopen Configuration Tool	Version 1.00A or later

CANopen Configuration Tool

For CANopen Configuration Tool, please consult your local Mitsubishi representative.

■ Operating environment, installation and uninstallation

For the operating environment and installation/uninstallation of CANopen Configuration Tool, refer to the following.

 CANopen Configuration Tool Installation Instructions

■ Software license agreement

For the software license agreement to use CANopen Configuration Tool, refer to the following.

 Page 42 Software License Agreement

■ Operation methods and functions

For operation methods and functions of CANopen Configuration Tool, refer to the following.

 MELSEC iQ-R CANopen Module User's Manual (Application)

6 WIRING

This chapter describes the wiring for the RJ71CN91.

6.1 Terminal Block

Type of terminal block

The RJ71CN91 uses the following terminal block.

Name	Model	Contact
Transmission cable terminal block	MSTB2,5/5-STF-5,08AU-M	PHOENIX CONTACT GmbH & Co. KG (www.phoenixcontact.com)

Tightening torque

Tighten the terminal block screws within the following specified torque range.

Screw type	Tightening torque range
Terminal block mounting screw (M2.5 screw)	0.20 to 0.30N-m
Wiring installation screw (M3 screw)	0.50 to 0.60N-m

Tightening work requires a 0.6×3.5mm flathead screwdriver.

Before removing the transmission cable terminal block, check that terminal block mounting screws at both ends have been completely loosen (detached from the socket) and then pull it out.

Forcibly pulling out the transmission cable terminal block with the terminal block mounting screws at both ends engaged may damage the equipment.

Check that there is no short-circuit with loosen or untwisted wires before mounting, and then completely tighten the terminal block mounting screws at both ends.

Terminal name of terminal block

Terminal name of terminal block is as follows.

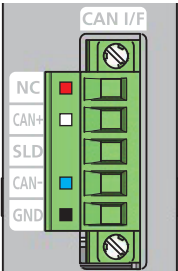
Terminal block	Terminal name	Description	Cable color
	NC	Signal name: CAN_V+ External power supply Make a connection as required as it is not used by the RJ71CN91.	Red
	CAN+	Signal name: CAN_H CAN_H bus line (dominant high)	White
	SLD	Signal name: CAN_SHLD CAN shield	—
	CAN-	Signal name: CAN_L CAN_L bus line (dominant low)	Blue
	GND	Signal name: CAN_GND CAN ground	Black

The terminal block has labels attached corresponding to the cable colors. Match the cable colors with the terminal block label colors to connect the CAN bus cable.

6.2 Wiring Methods

This section describes the wiring for transmission cable terminal block of the RJ71CN91.

Wiring for transmission cable terminal block

■Cable installation

Insert the cable into the wire insertion opening with the wiring installation screws loosened, and then tighten the wiring installation screws at an adequate torque. After the tightening, slightly pull the cable to check that the cable has been completely clamped.

■Disconnecting cable

Loosen the wiring installation screws for the cable to be disconnected and then pull out the cable.

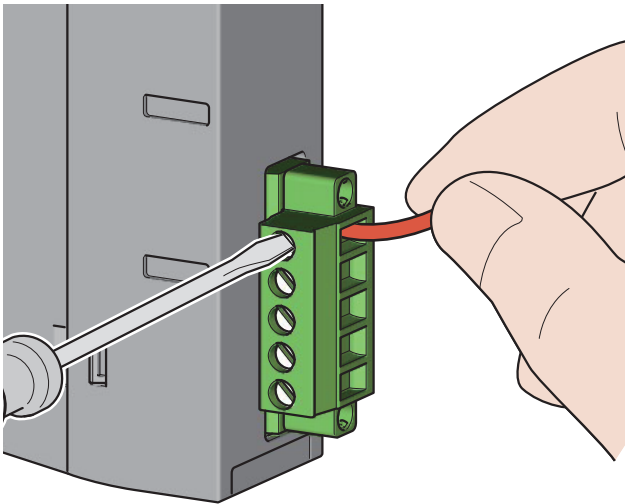

Precautions

Before connecting the CAN bus cable to the RJ71CN91, be sure to check the terminal name of the transmission cable terminal block. (☞ Page 23 Terminal name of terminal block)

When wiring for the transmission cable terminal block, observe the following precautions. Failure to do so may cause electric shock, short-circuit, disconnection, malfunction, or damage to the RJ71CN91.

- Be sure that wire diameter of the cable is in line with the dimensions listed in this manual. (☞ Page 25 Wiring Products)
- Twist the end of stranded wire and check that there is no loose wire.
- Do not solder the end of wire.
- Do not connect any cables more than the number specified or with a wire diameter not listed in the specification.
- Completely fix the cable to avoid a direct load to the transmission cable terminal block itself and the connection between the transmission cable terminal block and the RJ71CN91.

Example of wiring

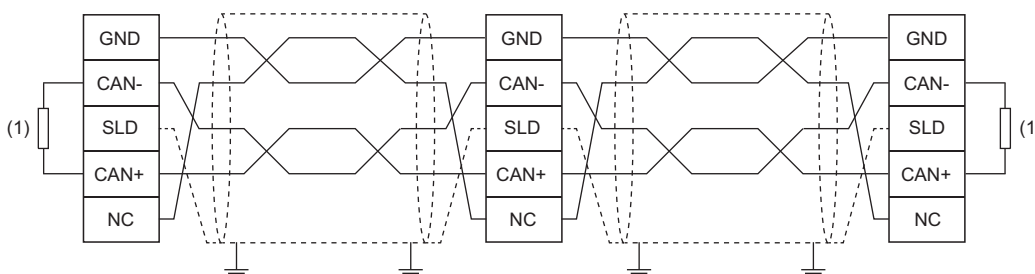

(1) Terminating resistor

6.3 Wiring Products

Application connector

Use 5-pin open style connectors.

For details on signal layout, refer to the following.

 Page 23 Terminal name of terminal block

CAN bus cable

Wire the CAN bus cable that meets the following specifications.

Item	Description
Cable type	Shielded twisted pair cable
Number of pairs	2
Applicable standard	ISO11898
Wire diameter*1	0.2 to 3.3mm ² (24 to 12 AWG)
Impedance	120Ω (95 to 140Ω)

*1 The maximum wire diameter of the included terminal block is 2.5mm². To use the cable with wire diameter exceeding 2.5mm², use a terminal block suited for the wire diameter of a cable used.

Cable specifications of the CAN bus cable available vary depending on the cable length.

Cable length	Wire diameter	Resistance per 1m
0 to 40m	0.25 to 0.34mm ²	70mΩ
40 to 300m	0.34 to 0.60mm ²	< 60mΩ
300 to 600m	0.50 to 0.60mm ²	< 40mΩ
600 to 1000m	0.75 to 0.80mm ²	< 26mΩ

Point

For compatible CAN bus cables, contact CiA.
For contact information, refer to the following.
www.can-cia.org

Terminating resistor used

In the CANopen network and CAN network, CAN+ and CAN- of the both ends of the network require a terminating resistor at 120Ω (100 to 130Ω). A 121Ω 1/4W resistor comes with this product.

7 COMMUNICATION EXAMPLES

This chapter describes examples of programming and start-up for the CANopen module.

7.1 Communication Example in CANopen 405 Mode (1)

This section describes communication examples using SDO communication.

System configuration

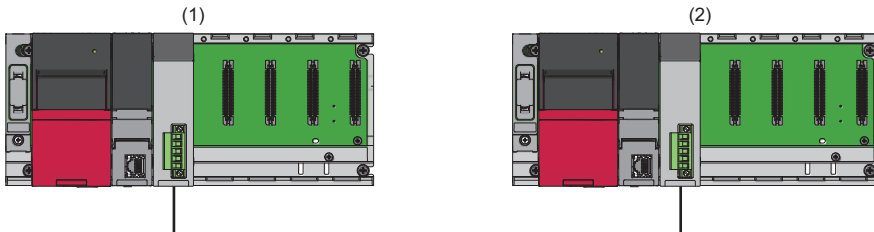

(1) CANopen node (NMT master)

- Power supply module: R61P
- CPU module: R04CPU
- CANopen node: RJ71CN91 (start I/O number: 0000H to 001FH)

(2) CANopen node (NMT slave)

- Power supply module: R61P
- CPU module: R04CPU
- CANopen node: RJ71CN91 (start I/O number: 0000H to 001FH)

Setting details

The following table lists the setting details of CANopen nodes.

Target node	Item	Description
CANopen node (1)	Node ID	1
	Baud rate	250kbps
	NMT type	NMT master
	Heartbeat setting	Heartbeat consumer (3200ms)
	TPDO1	CAN-ID: 0181H, send data size: 8 bytes
	TPDO2	CAN-ID: 0281H, send data size: 8 bytes
	RPDO1	CAN-ID: 0183H, receive data size: 1 byte
	RPDO2	CAN-ID: 0283H, receive data size: 4 bytes
CANopen node (2)	Node ID	3
	Baud rate	250kbps
	NMT type	NMT slave
	Heartbeat setting	Heartbeat producer (2100ms)
	TPDO1	CAN-ID: 0183H, send data size: 1 byte
	TPDO2	CAN-ID: 0283H, send data size: 4 bytes
	RPDO1	CAN-ID: 0181H, receive data size: 8 bytes
	RPDO2	CAN-ID: 0281H, receive data size: 8 bytes

Parameter setting

Connect the engineering tool to the CPU module and set the parameters.

Module parameter setting

1. Set the CPU module as follows.

 [Project] ⇒ [New]

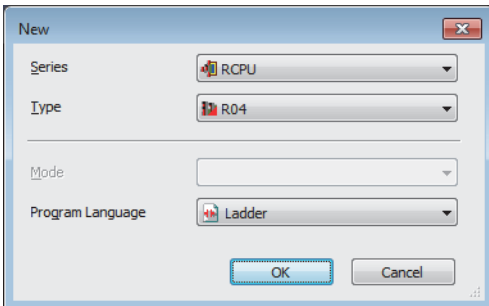

2. Click the [OK] button to add the module labels of the CPU module.

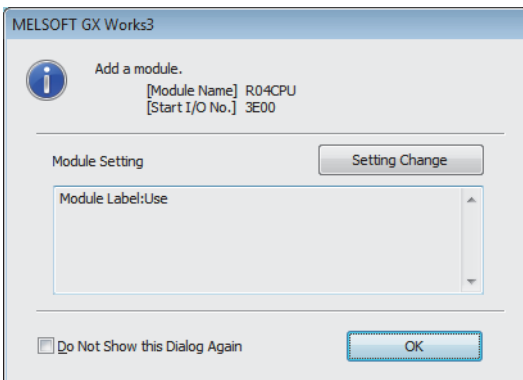

3. Set the RJ71CN91 as follows.

 [Navigation window] ⇒ [Parameter] ⇒ [Module Information] ⇒ Right-click ⇒ [Add New Module]

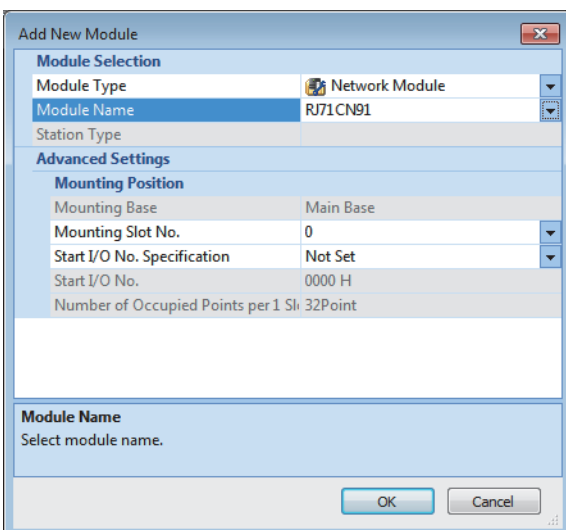

4. Write the set parameters to the CPU module. Then reset the CPU module or power off and on the system.

 [Online] ⇒ [Write to PLC]

Point

In the program examples, default values are used for parameters that are not shown above. For the parameters, refer to the following.

 MELSEC iQ-R CANopen Module User's Manual (Application)

CANopen Configuration Tool setting

■CANopen node (NMT master) setting

1. Start up CANopen Configuration Tool and create a project.

 [Project] ⇒ [New]

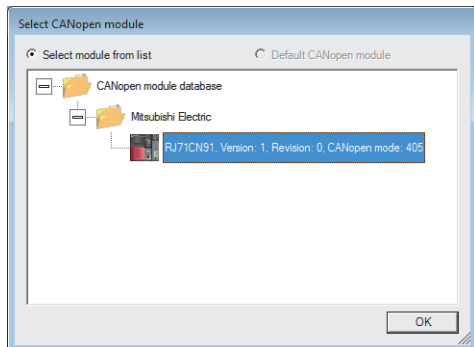

2. Set the items in "CANopen Configuration" as follows.

 [Navigator] ⇒ [CANopen Configuration]

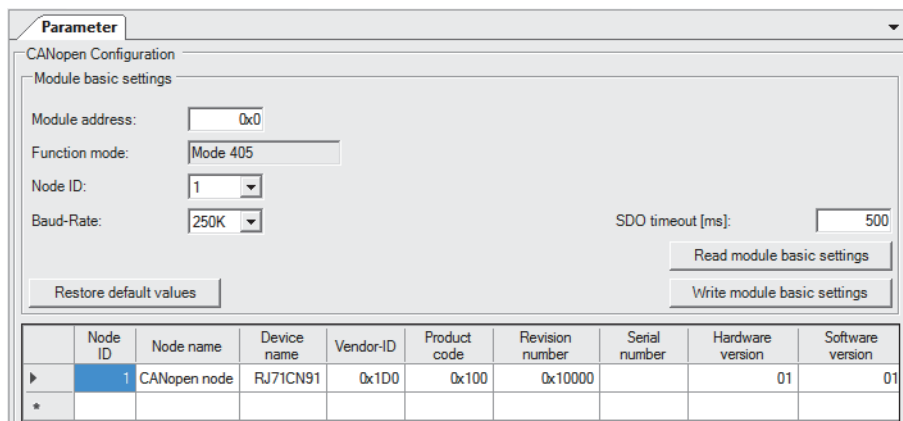

3. Set the items in "TPDO" as follows.

- PDO list

 [Navigator] ⇒ [CANopen Configuration] ⇒ [CANopen node] ⇒ [Transmit PDO]

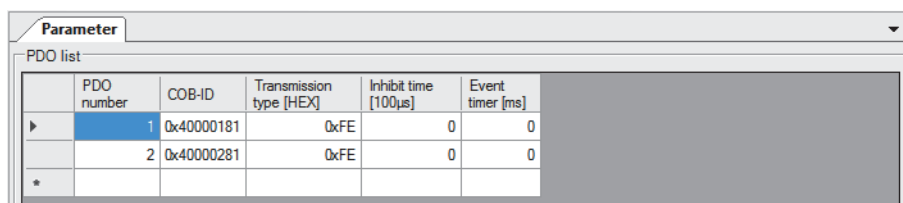

- PDO1

 [Navigator] ⇒ [CANopen Configuration] ⇒ [CANopen node] ⇒ [Transmit PDO] ⇒ [PDO 1]

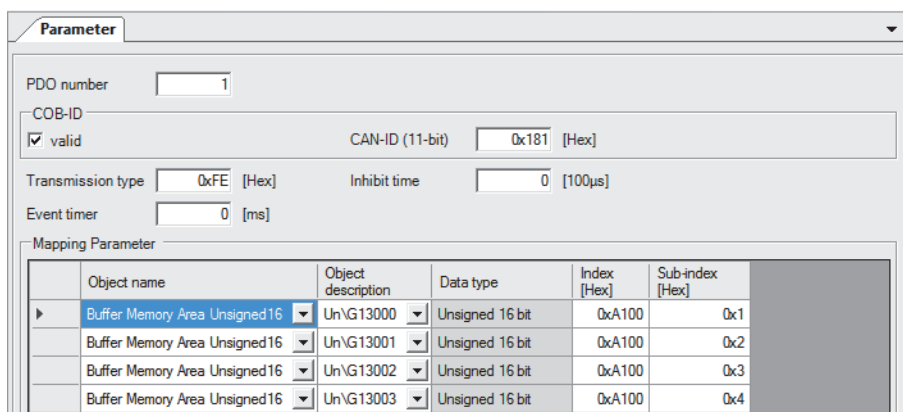

- PDO2

[Navigator] ⇒ [CANopen Configuration] ⇒ [CANopen node] ⇒ [Transmit PDO] ⇒ [PDO 2]

Parameter

PDO number: 2

COB-ID: valid CAN-ID (11-bit): 0x281 [Hex]

Transmission type: 0xFE [Hex] Inhibit time: 0 [100µs]

Event timer: 0 [ms]

Mapping Parameter

	Object name	Object description	Data type	Index [Hex]	Sub-index [Hex]
▶	Buffer Memory Area Unsigned16	Un\G13004	Unsigned 16 bit	0xA100	0x5
	Buffer Memory Area Unsigned16	Un\G13005	Unsigned 16 bit	0xA100	0x6
	Buffer Memory Area Unsigned16	Un\G13006	Unsigned 16 bit	0xA100	0x7
	Buffer Memory Area Unsigned16	Un\G13007	Unsigned 16 bit	0xA100	0x8

4. Set the items in "RPDO" as follows.

- PDO list

[Navigator] ⇒ [CANopen Configuration] ⇒ [CANopen node] ⇒ [Receive PDO]

Parameter

PDO list

	PDO number	COB-ID	Transmission type [HEX]
▶	1	0x0000183	0xFE
	2	0x0000283	0xFE
*			

- PDO1

[Navigator] ⇒ [CANopen Configuration] ⇒ [CANopen node] ⇒ [Receive PDO] ⇒ [PDO 1]

Parameter

PDO number: 1

COB-ID: valid CAN-ID (11-bit): 0x183 [Hex]

Transmission type: 0xFE [Hex]

Mapping Parameter

	Object name	Object description	Data type	Index [Hex]	Sub-index [Hex]
▶	Buffer Memory Area Unsigned8	Un\G10000 LByte	Unsigned 8 bit	0xA4C0	0x1
*					

- PDO2

[Navigator] ⇒ [CANopen Configuration] ⇒ [CANopen node] ⇒ [Receive PDO] ⇒ [PDO 2]

Parameter

PDO number: 2

COB-ID: valid CAN-ID (11-bit): 0x283 [Hex]

Transmission type: 0xFE [Hex]

Mapping Parameter

	Object name	Object description	Data type	Index [Hex]	Sub-index [Hex]
▶	Buffer Memory Area Unsigned16	Un\G10004	Unsigned 16 bit	0xA580	0x5
	Buffer Memory Area Unsigned16	Un\G10005	Unsigned 16 bit	0xA580	0x6
*					

5. Set the items in "NMT settings" as follows.

- NMT master / slave

[Navigator] ⇒ [CANopen Configuration] ⇒ [CANopen node] ⇒ [NMT settings] ⇒ [NMT master / slave]

- NMT slave assignment

[Navigator] ⇒ [CANopen Configuration] ⇒ [CANopen node] ⇒ [NMT settings] ⇒ [NMT master / slave] ⇒ [NMT Slave assignment]

Node ID	NMT slave	NMT boot slave	Mandatory	Reset communication	Retry factor	Guard time	Device type	Vendor-ID	Product code	Revision number	Serial number
3	<input checked="" type="checkbox"/>	<input checked="" type="checkbox"/>	<input type="checkbox"/>	<input type="checkbox"/>	0	0	0	0x0	0	0x0	0x0
*	<input type="checkbox"/>	<input type="checkbox"/>	<input type="checkbox"/>	<input type="checkbox"/>							

- Heartbeat

[Navigator] ⇒ [CANopen Configuration] ⇒ [CANopen node] ⇒ [NMT settings] ⇒ [Heartbeat]

Node ID	Consumer heartbeat time [ms]
3	3200
**	

6. Write the set parameters to the CPU module of the CANopen node (NMT master). Then reset the CPU module or power off and on the system.

[Online] ⇒ [Download Configuration]

■CANopen node (NMT slave) setting

1. Start up CANopen Configuration Tool and create a project.

[Project] ⇒ [New]

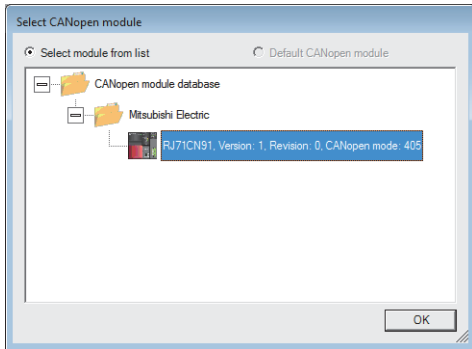

2. Set the items in "CANopen Configuration" as follows.

[Navigator] ⇒ [CANopen Configuration]

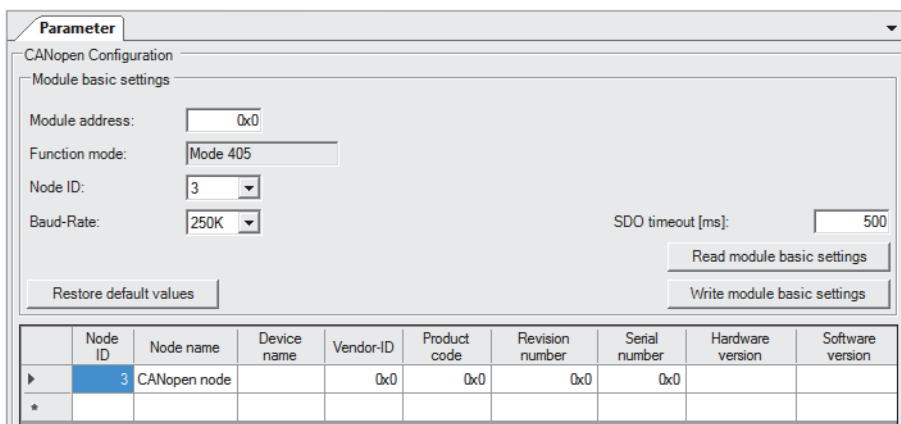

3. Set the items in "TPDO" as follows.

- PDO list

[Navigator] ⇒ [CANopen Configuration] ⇒ [CANopen node] ⇒ [Transmit PDO]

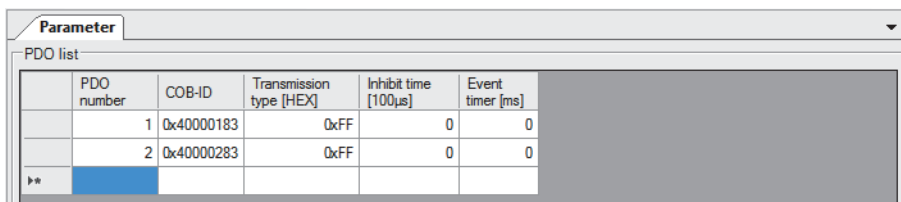

- PDO1

[Navigator] ⇒ [CANopen Configuration] ⇒ [CANopen node] ⇒ [Transmit PDO] ⇒ [PDO 1]

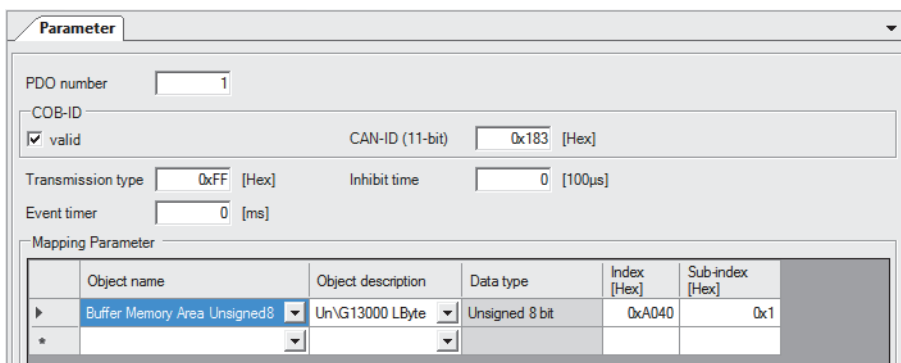

- PDO2

[Navigator] ⇒ [CANopen Configuration] ⇒ [CANopen node] ⇒ [Transmit PDO] ⇒ [PDO 2]

Parameter

PDO number:

COB-ID: valid CAN-ID (11-bit): [Hex]

Transmission type: [Hex] Inhibit time: [100µs]

Event timer: [ms]

Mapping Parameter

	Object name	Object description	Data type	Index [Hex]	Sub-index [Hex]
▶	Buffer Memory Area Unsigned16	Un\G13004	Unsigned 16 bit	0xA100	0x5
	Buffer Memory Area Unsigned16	Un\G13005	Unsigned 16 bit	0xA100	0x6
*					

4. Set the items in "RPDO" as follows.

- PDO list

[Navigator] ⇒ [CANopen Configuration] ⇒ [CANopen node] ⇒ [Receive PDO]

Parameter

PDO list

	PDO number	COB-ID	Transmission type [HEX]
	1	0x00000181	0xFF
	2	0x00000281	0xFF
▶*			

- PDO1

[Navigator] ⇒ [CANopen Configuration] ⇒ [CANopen node] ⇒ [Receive PDO] ⇒ [PDO 1]

Parameter

PDO number:

COB-ID: valid CAN-ID (11-bit): [Hex]

Transmission type: [Hex]

Mapping Parameter

	Object name	Object description	Data type	Index [Hex]	Sub-index [Hex]
▶	Buffer Memory Area Unsigned16	Un\G10000	Unsigned 16 bit	0xA580	0x1
	Buffer Memory Area Unsigned16	Un\G10001	Unsigned 16 bit	0xA580	0x2
	Buffer Memory Area Unsigned16	Un\G10002	Unsigned 16 bit	0xA580	0x3
	Buffer Memory Area Unsigned16	Un\G10003	Unsigned 16 bit	0xA580	0x4

- PDO2

[Navigator] ⇒ [CANopen Configuration] ⇒ [CANopen node] ⇒ [Receive PDO] ⇒ [PDO 2]

Parameter

PDO number:

COB-ID: valid CAN-ID (11-bit): [Hex]

Transmission type: [Hex]

Mapping Parameter

	Object name	Object description	Data type	Index [Hex]	Sub-index [Hex]
▶	Buffer Memory Area Unsigned16	Un\G10004	Unsigned 16 bit	0xA580	0x5
	Buffer Memory Area Unsigned16	Un\G10005	Unsigned 16 bit	0xA580	0x6
	Buffer Memory Area Unsigned16	Un\G10006	Unsigned 16 bit	0xA580	0x7
	Buffer Memory Area Unsigned16	Un\G10007	Unsigned 16 bit	0xA580	0x8

5. Set the items in "NMT settings" as follows.

- Heartbeat

 [Navigator] ⇒ [CANopen Configuration] ⇒ [CANopen node] ⇒ [NMT settings] ⇒ [Heartbeat]

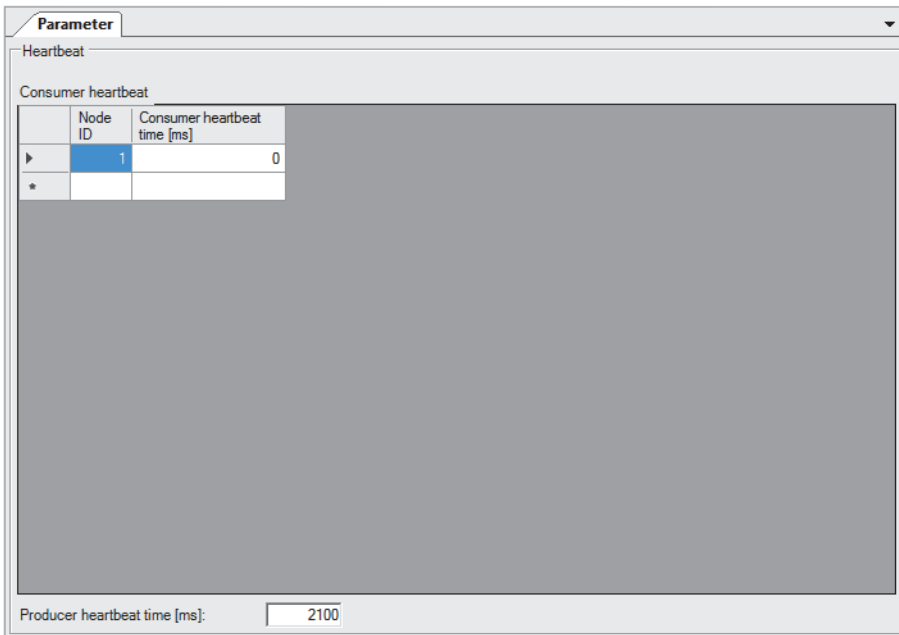

6. Write the set parameters to the CPU module of the CANopen node (NMT slave). Then reset the CPU module or power off and on the system.

 [Online] ⇒ [Download Configuration]

Program examples

NMT state acquisition program

Acquiring a current NMT state

Classification	Label name	Description	Device
Module label	RCN91_1.bSts_Module_Ready	Module READY	X0
	RCN91_1.bSts_Module_Error	RJ71CN91 error	XF
	RCN91_1.u127NMT_Error_Control_Status_D[2]	NMT error control status (CANopen node 3) bit1: Heartbeat enabled	U0\G403
	RCN91_1.u127NMT_State_D[2]	NMT state (CANopen node 3)	U0\G603

Label Name	Data Type	Class	Assign (Device/Label)
bNode3PreOperational	Bit	VAR_GLOBAL	M20
bNode3Operational	Bit	VAR_GLOBAL	M21

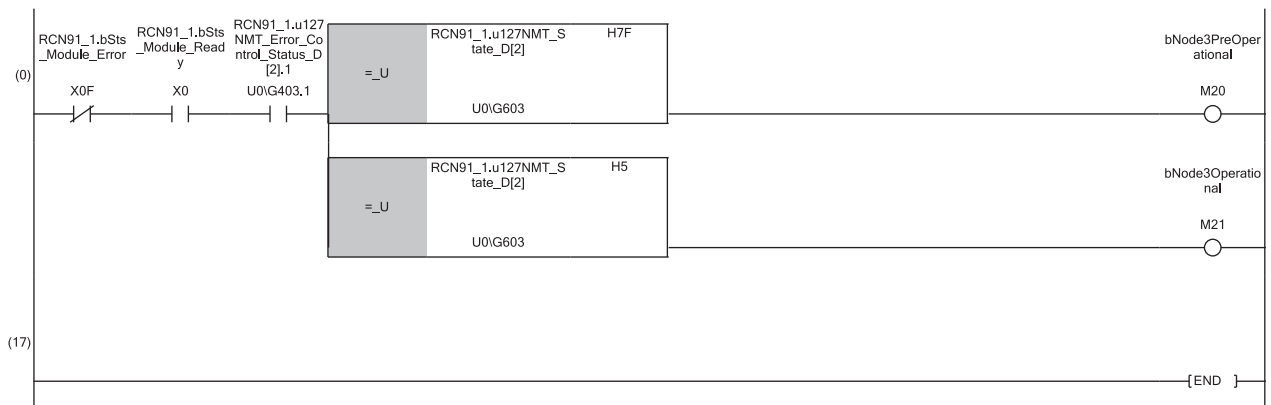

SDO write request command issue program

Issuing the SDO write request command to the CANopen node with node ID of 3

Classification	Label name	Description	Device																																																								
Module label	RCN91_1.bSts_Module_Ready	Module READY	X0																																																								
	RCN91_1.bSts_Module_Error	RJ71CN91 error	XF																																																								
	RCN91_1.u127NMT_Error_Control_Status_D[2]	NMT error control status (CANopen node 3)	U0/G403																																																								
Label to be defined	Define global labels as shown below:																																																										
	<table border="1"> <thead> <tr> <th>Label Name</th> <th>Data Type</th> <th>Class</th> <th>Assign (Device/Label)</th> </tr> </thead> <tbody> <tr><td>bNode3HeartbeatON</td><td>Bit</td><td>VAR_GLOBAL</td><td>M103</td></tr> <tr><td>bSDOWriteStart</td><td>Bit</td><td>VAR_GLOBAL</td><td>M40</td></tr> <tr><td>bNode3PreOperational</td><td>Bit</td><td>VAR_GLOBAL</td><td>M20</td></tr> <tr><td>bNode3Operational</td><td>Bit</td><td>VAR_GLOBAL</td><td>M21</td></tr> <tr><td>bSDOWriteEN</td><td>Bit</td><td>VAR_GLOBAL</td><td>M41</td></tr> <tr><td>wWriteDataLength</td><td>Word [Signed]</td><td>VAR_GLOBAL</td><td>D20</td></tr> <tr><td>uWriteData</td><td>Word [Unsigned]/Bit String [16-bit](0..61)</td><td>VAR_GLOBAL</td><td>D21</td></tr> <tr><td>bSDOWriteENO</td><td>Bit</td><td>VAR_GLOBAL</td><td>M42</td></tr> <tr><td>bSDOWriteOK</td><td>Bit</td><td>VAR_GLOBAL</td><td>M43</td></tr> <tr><td>bSDOWriteErr</td><td>Bit</td><td>VAR_GLOBAL</td><td>M44</td></tr> <tr><td>dWriteErrorCode2</td><td>Double Word [Signed]</td><td>VAR_GLOBAL</td><td>D200</td></tr> <tr><td>bCompleted</td><td>Bit</td><td>VAR_GLOBAL</td><td>M1000</td></tr> <tr><td>bErrorFlag</td><td>Bit</td><td>VAR_GLOBAL</td><td>M1001</td></tr> </tbody> </table>	Label Name	Data Type	Class	Assign (Device/Label)	bNode3HeartbeatON	Bit	VAR_GLOBAL	M103	bSDOWriteStart	Bit	VAR_GLOBAL	M40	bNode3PreOperational	Bit	VAR_GLOBAL	M20	bNode3Operational	Bit	VAR_GLOBAL	M21	bSDOWriteEN	Bit	VAR_GLOBAL	M41	wWriteDataLength	Word [Signed]	VAR_GLOBAL	D20	uWriteData	Word [Unsigned]/Bit String [16-bit](0..61)	VAR_GLOBAL	D21	bSDOWriteENO	Bit	VAR_GLOBAL	M42	bSDOWriteOK	Bit	VAR_GLOBAL	M43	bSDOWriteErr	Bit	VAR_GLOBAL	M44	dWriteErrorCode2	Double Word [Signed]	VAR_GLOBAL	D200	bCompleted	Bit	VAR_GLOBAL	M1000	bErrorFlag	Bit	VAR_GLOBAL	M1001		
Label Name	Data Type	Class	Assign (Device/Label)																																																								
bNode3HeartbeatON	Bit	VAR_GLOBAL	M103																																																								
bSDOWriteStart	Bit	VAR_GLOBAL	M40																																																								
bNode3PreOperational	Bit	VAR_GLOBAL	M20																																																								
bNode3Operational	Bit	VAR_GLOBAL	M21																																																								
bSDOWriteEN	Bit	VAR_GLOBAL	M41																																																								
wWriteDataLength	Word [Signed]	VAR_GLOBAL	D20																																																								
uWriteData	Word [Unsigned]/Bit String [16-bit](0..61)	VAR_GLOBAL	D21																																																								
bSDOWriteENO	Bit	VAR_GLOBAL	M42																																																								
bSDOWriteOK	Bit	VAR_GLOBAL	M43																																																								
bSDOWriteErr	Bit	VAR_GLOBAL	M44																																																								
dWriteErrorCode2	Double Word [Signed]	VAR_GLOBAL	D200																																																								
bCompleted	Bit	VAR_GLOBAL	M1000																																																								
bErrorFlag	Bit	VAR_GLOBAL	M1001																																																								

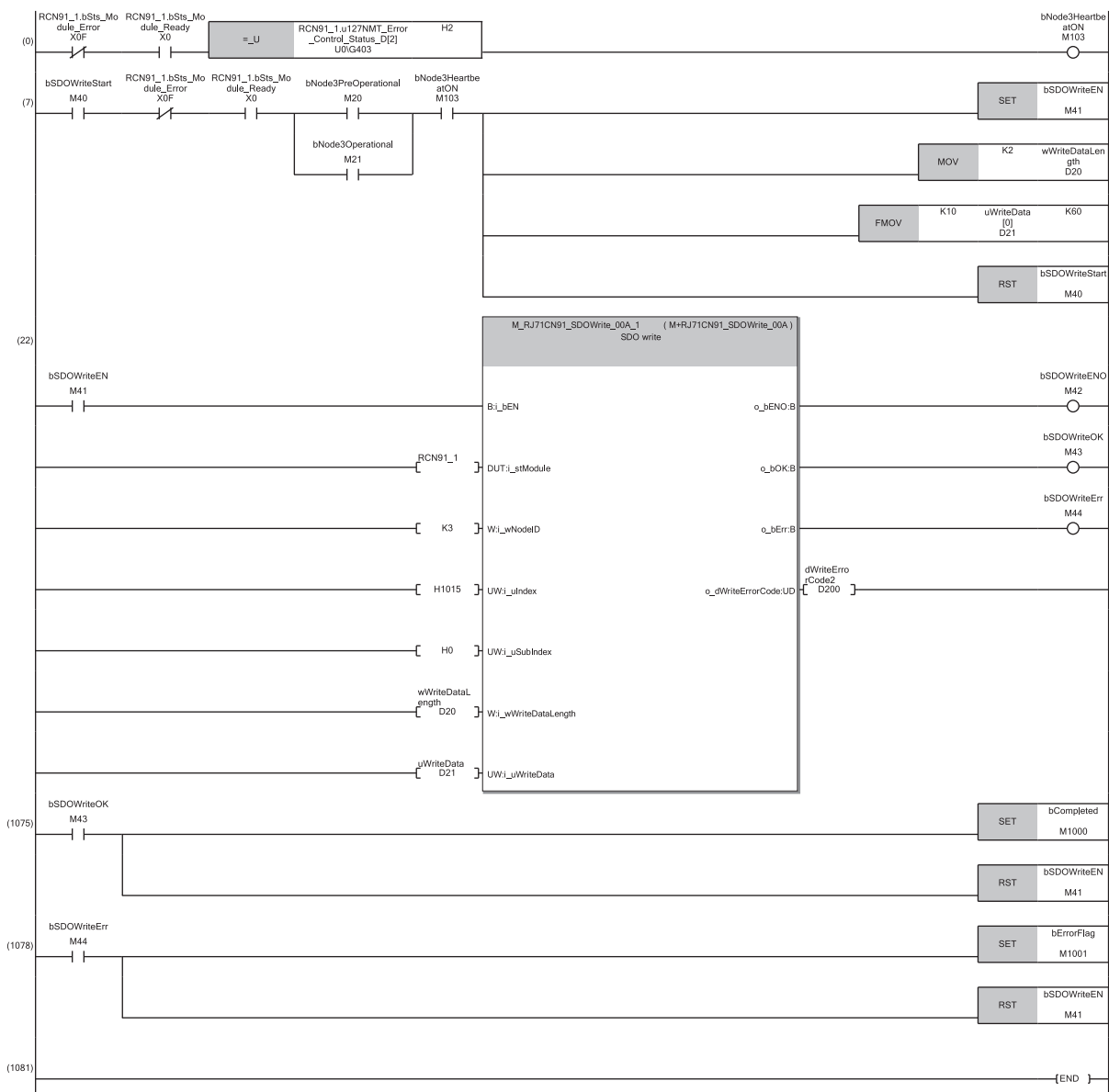

Remote node start issue program

Issuing the remote node start to all remote nodes

Classification	Label name	Description	Device																												
Module label	RCN91_1	Module label of the RJ71CN91	—																												
Label to be defined	Define global labels as shown below:																														
	<table border="1"> <thead> <tr> <th>Label Name</th> <th>Data Type</th> <th>Class</th> <th>Assign (Device/Label)</th> </tr> </thead> <tbody> <tr> <td>bNMTRRequestWriteENO</td> <td>Bit</td> <td>VAR_GLOBAL</td> <td>M61</td> </tr> <tr> <td>bNMTRRequestWriteOK</td> <td>Bit</td> <td>VAR_GLOBAL</td> <td>M62</td> </tr> <tr> <td>bNMTRRequestWriteErr</td> <td>Bit</td> <td>VAR_GLOBAL</td> <td>M63</td> </tr> <tr> <td>bCompleted</td> <td>Bit</td> <td>VAR_GLOBAL</td> <td>M1000</td> </tr> <tr> <td>bErrorFlag</td> <td>Bit</td> <td>VAR_GLOBAL</td> <td>M1001</td> </tr> <tr> <td>bNMTRRequestWriteEN</td> <td>Bit</td> <td>VAR_GLOBAL</td> <td>M60</td> </tr> </tbody> </table>	Label Name	Data Type	Class	Assign (Device/Label)	bNMTRRequestWriteENO	Bit	VAR_GLOBAL	M61	bNMTRRequestWriteOK	Bit	VAR_GLOBAL	M62	bNMTRRequestWriteErr	Bit	VAR_GLOBAL	M63	bCompleted	Bit	VAR_GLOBAL	M1000	bErrorFlag	Bit	VAR_GLOBAL	M1001	bNMTRRequestWriteEN	Bit	VAR_GLOBAL	M60		
Label Name	Data Type	Class	Assign (Device/Label)																												
bNMTRRequestWriteENO	Bit	VAR_GLOBAL	M61																												
bNMTRRequestWriteOK	Bit	VAR_GLOBAL	M62																												
bNMTRRequestWriteErr	Bit	VAR_GLOBAL	M63																												
bCompleted	Bit	VAR_GLOBAL	M1000																												
bErrorFlag	Bit	VAR_GLOBAL	M1001																												
bNMTRRequestWriteEN	Bit	VAR_GLOBAL	M60																												

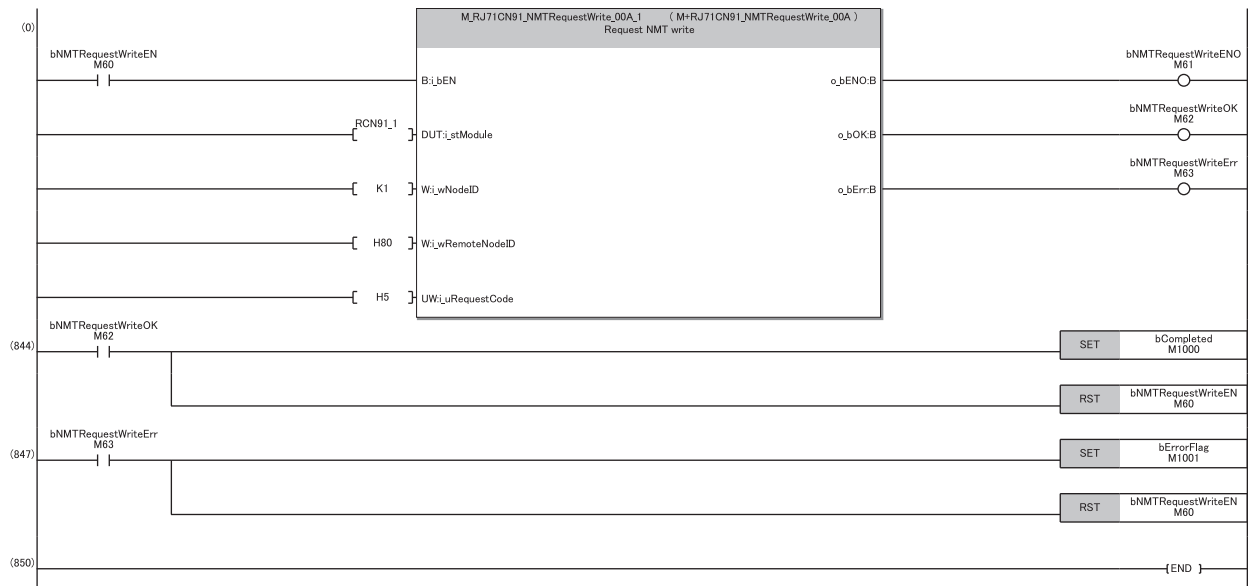

SDO read request command issue program

Issuing the SDO read request command to the CANopen node with node ID of 3

Classification	Label name	Description	Device																																								
Module label	RCN91_1	Module label of the RJ71CN91	—																																								
	RCN91_1.bSts_Module_Ready	Module READY	X0																																								
	RCN91_1.bSts_Module_Error	RJ71CN91 error	XF																																								
Label to be defined	Define global labels as shown below:																																										
	<table border="1"> <thead> <tr> <th>Label Name</th> <th>Data Type</th> <th>Class</th> <th>Assign (Device/Label)</th> </tr> </thead> <tbody> <tr> <td>bCompleted</td> <td>Bit</td> <td>VAR_GLOBAL</td> <td>M1000</td> </tr> <tr> <td>bErrorFlag</td> <td>Bit</td> <td>VAR_GLOBAL</td> <td>M1001</td> </tr> <tr> <td>bSDOReadErr</td> <td>Bit</td> <td>VAR_GLOBAL</td> <td>M73</td> </tr> <tr> <td>bSDOReadENO</td> <td>Bit</td> <td>VAR_GLOBAL</td> <td>M71</td> </tr> <tr> <td>bSDOReadOK</td> <td>Bit</td> <td>VAR_GLOBAL</td> <td>M72</td> </tr> <tr> <td>wReadDataLength</td> <td>Word [Signed]</td> <td>VAR_GLOBAL</td> <td>D40</td> </tr> <tr> <td>uReadData</td> <td>Word [Unsigned]/Bit String [16-bit](0..61)</td> <td>VAR_GLOBAL</td> <td>D400</td> </tr> <tr> <td>dReadErrorCode2</td> <td>Double Word [Unsigned]/Bit String [32-bit]</td> <td>VAR_GLOBAL</td> <td>D41</td> </tr> <tr> <td>bSDOReadEN</td> <td>Bit</td> <td>VAR_GLOBAL</td> <td>M70</td> </tr> </tbody> </table>	Label Name	Data Type	Class	Assign (Device/Label)	bCompleted	Bit	VAR_GLOBAL	M1000	bErrorFlag	Bit	VAR_GLOBAL	M1001	bSDOReadErr	Bit	VAR_GLOBAL	M73	bSDOReadENO	Bit	VAR_GLOBAL	M71	bSDOReadOK	Bit	VAR_GLOBAL	M72	wReadDataLength	Word [Signed]	VAR_GLOBAL	D40	uReadData	Word [Unsigned]/Bit String [16-bit](0..61)	VAR_GLOBAL	D400	dReadErrorCode2	Double Word [Unsigned]/Bit String [32-bit]	VAR_GLOBAL	D41	bSDOReadEN	Bit	VAR_GLOBAL	M70		
Label Name	Data Type	Class	Assign (Device/Label)																																								
bCompleted	Bit	VAR_GLOBAL	M1000																																								
bErrorFlag	Bit	VAR_GLOBAL	M1001																																								
bSDOReadErr	Bit	VAR_GLOBAL	M73																																								
bSDOReadENO	Bit	VAR_GLOBAL	M71																																								
bSDOReadOK	Bit	VAR_GLOBAL	M72																																								
wReadDataLength	Word [Signed]	VAR_GLOBAL	D40																																								
uReadData	Word [Unsigned]/Bit String [16-bit](0..61)	VAR_GLOBAL	D400																																								
dReadErrorCode2	Double Word [Unsigned]/Bit String [32-bit]	VAR_GLOBAL	D41																																								
bSDOReadEN	Bit	VAR_GLOBAL	M70																																								

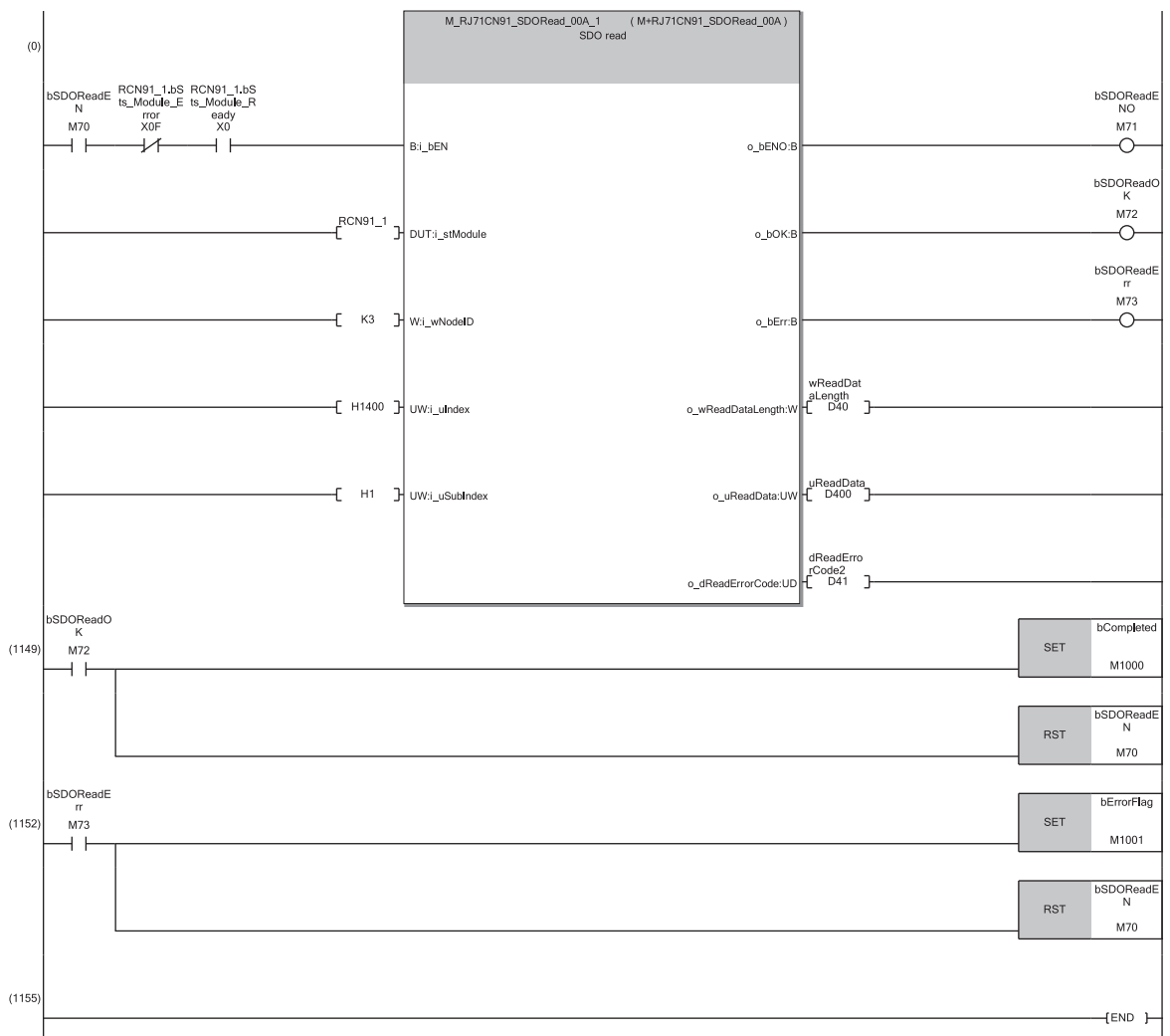

7.2 Communication Example in CANopen 405 Mode (2)

This section describes communication examples using PDO communication.

System configuration

For the system configuration, refer to the following.

☞ Page 26 System configuration

Parameter setting

Connect the engineering tool to the CPU module and set the parameters.

For the setting of items other than these ones, refer to the following.

☞ Page 27 Parameter setting

Module parameter setting

1. Set the item in "Basic Setting" as follows.

☞ [Navigation window] ⇒ [Parameter] ⇒ [Module Information] ⇒ [RJ71CN91] ⇒ [Module Parameter] ⇒ [Basic Setting]

Item	Setting Value
Data Exchange Setting	Sets the data exchange method of the buffer memory.
PDO data exchange method	Refresh

2. Set the items in "Refresh Setting" as follows.

☞ [Navigation window] ⇒ [Parameter] ⇒ [Module Information] ⇒ [RJ71CN91] ⇒ [Module Parameter] ⇒ [Refresh Setting]

- Transfer to intelligent module

Item	Setting Value
Transfer to intelligent module	Transfers the data of the specified device to the buffer memory.
TPDO	Refresh setting of TPDO
0-63word	D13000
64-127word	
128-191word	
192-255word	
256-319word	

- Transfer to CPU

Item	Setting Value
Transfer to CPU	Transfer the buffer memory data to the specified device.
Communication Status	
Error Status	
NMT error control state	
NMT state	D601
RPDO	Refresh setting of RPDO
0-63word	D10000
64-127word	
128-191word	
192-255word	

Program examples

TPDO data write program

Writing data to TPDO with PDO number: 1

Classification	Label name	Description	Device																								
Module label	RCN91_1.bSts_Module_Ready	Module READY	X0																								
	RCN91_1.bSts_Module_Error	RJ71CN91 error	XF																								
Label to be defined	Define global labels as shown below:																										
	<table border="1"> <thead> <tr> <th>Label Name</th> <th>Data Type</th> <th>Class</th> <th>Assign (Device/Label)</th> </tr> </thead> <tbody> <tr> <td>bPDOWriteStart</td> <td>Bit</td> <td>VAR_GLOBAL</td> <td>M80</td> </tr> <tr> <td>bPDOWriteEN</td> <td>Bit</td> <td>VAR_GLOBAL</td> <td>M85</td> </tr> <tr> <td>uWriteData1</td> <td>Word [Unsigned]/Bit String [16-bit](0..3)</td> <td>VAR_GLOBAL</td> <td>D51</td> </tr> <tr> <td>uWriteData2</td> <td>Word [Unsigned]/Bit String [16-bit](0..3)</td> <td>VAR_GLOBAL</td> <td>D55</td> </tr> <tr> <td>uTPDO0to63</td> <td>Word [Unsigned]/Bit String [16-bit](0..63)</td> <td>VAR_GLOBAL</td> <td>D13000</td> </tr> </tbody> </table>	Label Name	Data Type	Class	Assign (Device/Label)	bPDOWriteStart	Bit	VAR_GLOBAL	M80	bPDOWriteEN	Bit	VAR_GLOBAL	M85	uWriteData1	Word [Unsigned]/Bit String [16-bit](0..3)	VAR_GLOBAL	D51	uWriteData2	Word [Unsigned]/Bit String [16-bit](0..3)	VAR_GLOBAL	D55	uTPDO0to63	Word [Unsigned]/Bit String [16-bit](0..63)	VAR_GLOBAL	D13000		
Label Name	Data Type	Class	Assign (Device/Label)																								
bPDOWriteStart	Bit	VAR_GLOBAL	M80																								
bPDOWriteEN	Bit	VAR_GLOBAL	M85																								
uWriteData1	Word [Unsigned]/Bit String [16-bit](0..3)	VAR_GLOBAL	D51																								
uWriteData2	Word [Unsigned]/Bit String [16-bit](0..3)	VAR_GLOBAL	D55																								
uTPDO0to63	Word [Unsigned]/Bit String [16-bit](0..63)	VAR_GLOBAL	D13000																								

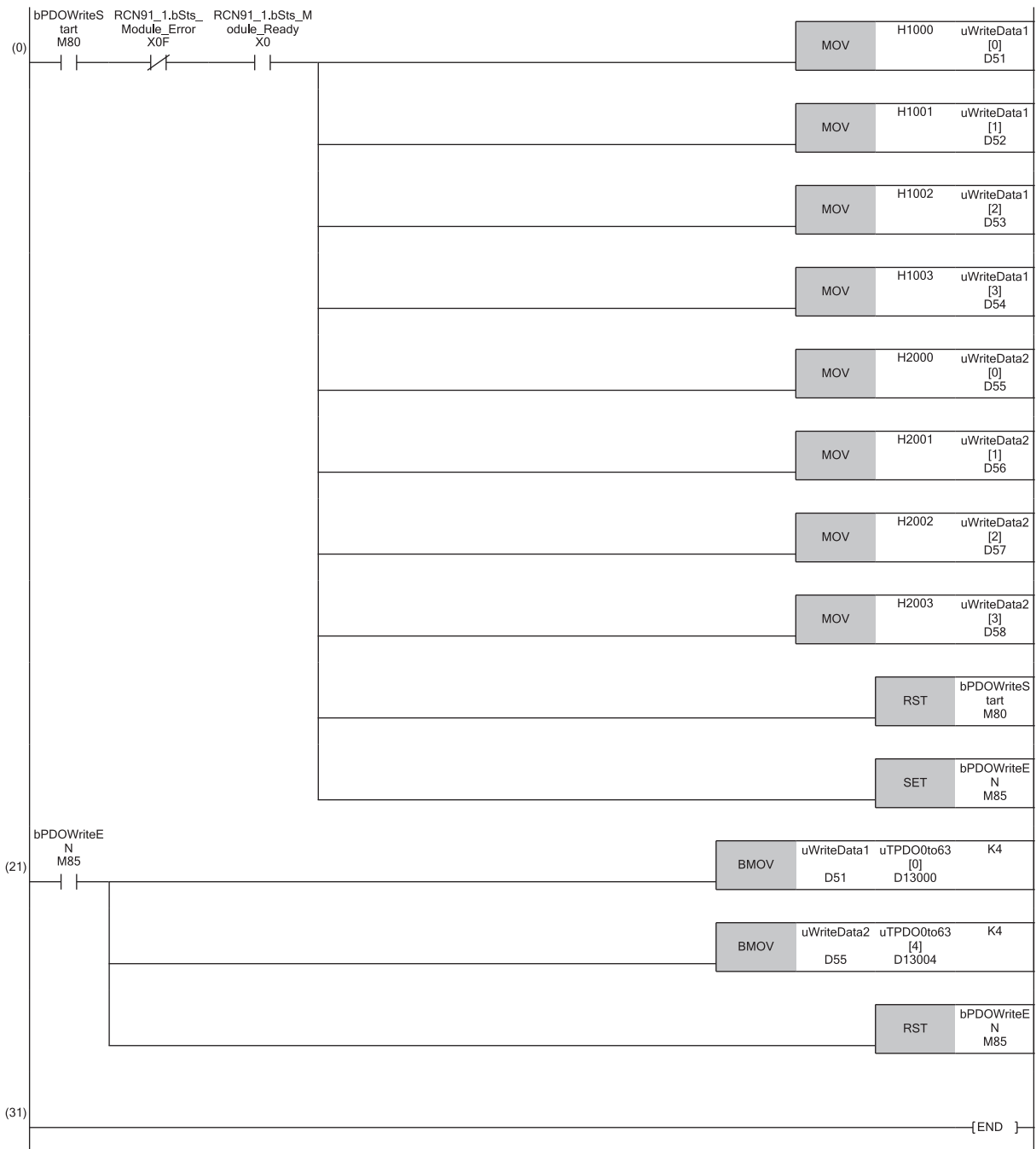

RPDO data read program

Reading data from RPDO with PDO number: 1

Classification	Label name	Description	Device																				
Module label	RCN91_1.bSts_Module_Ready	Module READY	X0																				
	RCN91_1.bSts_Module_Error	RJ71CN91 error	XF																				
Label to be defined	Define global labels as shown below:																						
	<table border="1"> <thead> <tr> <th>Label Name</th> <th>Data Type</th> <th>Class</th> <th>Assign (Device/Label)</th> </tr> </thead> <tbody> <tr> <td>bPDOReadStart</td> <td>Bit</td> <td>VAR_GLOBAL</td> <td>M90</td> </tr> <tr> <td>uReadData1</td> <td>Word [Unsigned]/Bit String [16-bit]</td> <td>VAR_GLOBAL</td> <td>D61</td> </tr> <tr> <td>uReadData2</td> <td>Word [Unsigned]/Bit String [16-bit](0..1)</td> <td>VAR_GLOBAL</td> <td>D65</td> </tr> <tr> <td>uRPDO0to63</td> <td>Word [Unsigned]/Bit String [16-bit](0..63)</td> <td>VAR_GLOBAL</td> <td>D10000</td> </tr> </tbody> </table>	Label Name	Data Type	Class	Assign (Device/Label)	bPDOReadStart	Bit	VAR_GLOBAL	M90	uReadData1	Word [Unsigned]/Bit String [16-bit]	VAR_GLOBAL	D61	uReadData2	Word [Unsigned]/Bit String [16-bit](0..1)	VAR_GLOBAL	D65	uRPDO0to63	Word [Unsigned]/Bit String [16-bit](0..63)	VAR_GLOBAL	D10000		
Label Name	Data Type	Class	Assign (Device/Label)																				
bPDOReadStart	Bit	VAR_GLOBAL	M90																				
uReadData1	Word [Unsigned]/Bit String [16-bit]	VAR_GLOBAL	D61																				
uReadData2	Word [Unsigned]/Bit String [16-bit](0..1)	VAR_GLOBAL	D65																				
uRPDO0to63	Word [Unsigned]/Bit String [16-bit](0..63)	VAR_GLOBAL	D10000																				

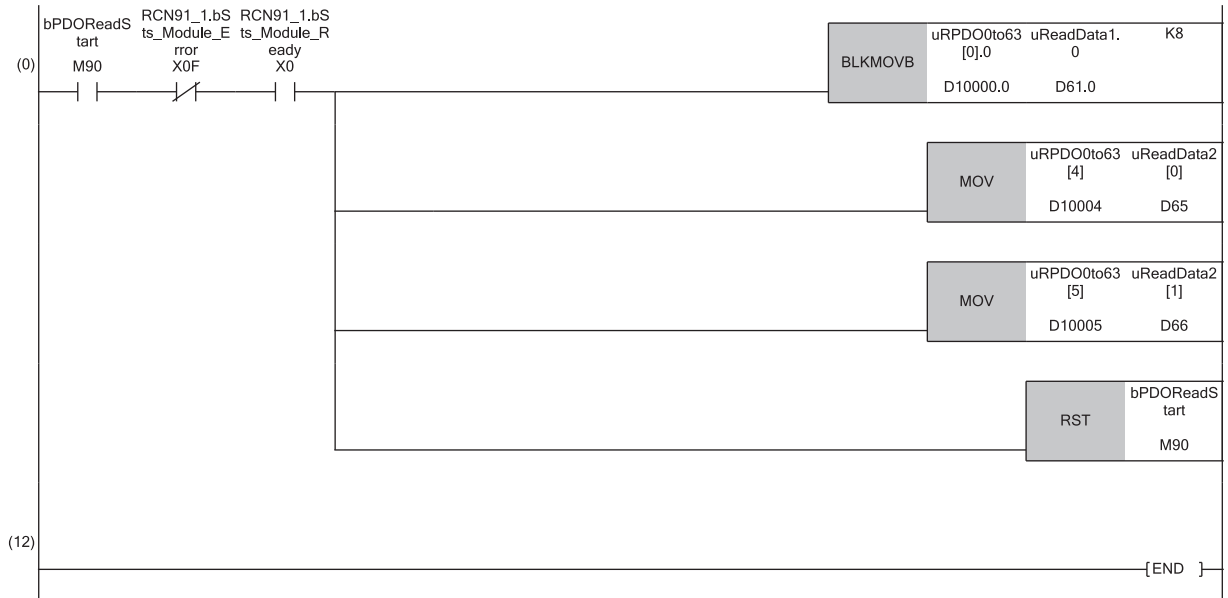

APPENDICES

Appendix 1 External Dimensions

External dimensions of the RJ71CN91 is as follows.

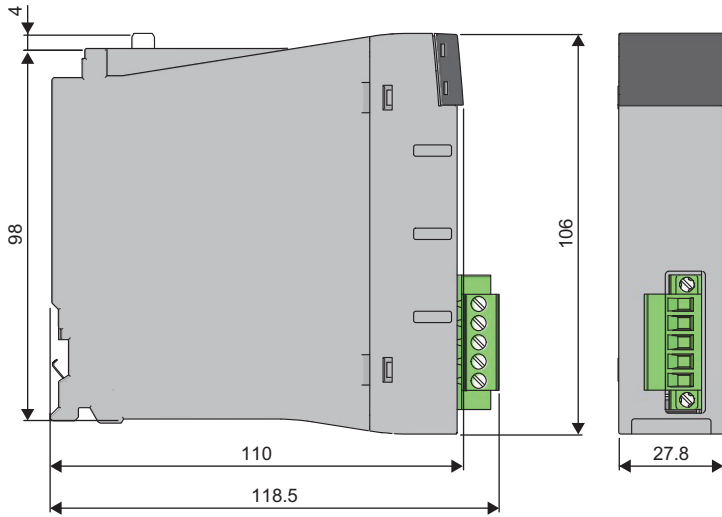

(Unit: mm)

Appendix 2 Software License Agreement

This section describes the Software License Agreement to use CANopen Configuration Tool.

Please ensure this notice is read.

Thank you for using our software products. This software is provided only on the condition that the customer reviews the following Software License Agreement (hereinafter referred to as "this license") before making use of this software and agrees to all terms and conditions of this license.

By agreeing to the contract when installing this software, the customer agrees to all clauses of this license.

Please note that this software cannot be used if the customer does not agree to this license.

Software License Agreement

This agreement is applicable to the software which sets parameters for the RJ71CN91 (hereinafter referred to as "this program" or "this software").

■Article 1 (License Grant)

Mitsubishi Electric Corporation (Mitsubishi) grants to the customers the following nonexclusive rights as long as this license remains effective.

(1) This is a right to use this software for the purpose of using Mitsubishi products.

■Article 2 (Scope of Liability)

(1) Mitsubishi is not liable for any damages or losses (including, but not limited to, loss of profits, business interruption, loss of business information or any other monetary damages) which arise from the use of other software products (including, but not limited to, OS, resident software or computers along with its peripherals) which are operated with this program, or the inability to use the program.

(2) Mitsubishi does not guarantee that the product quality and functions will be suitable for the user's intended use, and bears no responsibilities whatsoever for any warranties against defects or for product quality regarding this software, unless clearly stated within this license. The installation of this software shall be solely at the customer's risk and Mitsubishi shall not be responsible or liable for the use of this software and its consequences.

(3) In no event shall Mitsubishi be liable for any damages or other loss caused by or related to modifications to this program by the customer.

(4) In the event that a dispute with any third party has arisen or is likely to arise from any infringement claims against any third-party's industrial property rights or intellectual property rights such as copyright, etc. as a result of the use of this software and/or the sale of the customer's products, related to this software, the customer shall be obligated to settle the dispute at their own responsibility and expense.

(5) In no event shall Mitsubishi's liabilities, based on the articles of this license, exceed the amount actually paid to Mitsubishi or its agents, and distributors for this software by the customer.

■Article 3 (Software Specification Changes)

Mitsubishi shall retain the right to change any software specifications without prior notice.

■Article 4 (Copyrights)

The copyright of this software is reserved by the original copyright holder. However, the property rights of the recording media in which the Software is recorded on shall belong to the customer through payment of the price.

■Article 5 (Restrictions)

(1) The customer shall not use this software in order to use any third-party's products other than Mitsubishi's.

(2) The customer shall not use this software with any other method or purpose than specified in the technical documentation provided by Mitsubishi.

(3) The customer shall not reverse engineer, decompile, disassemble or modify the Program.

(4) The customer shall not sell, lend, rent or lease this software.

(5) The customer is permitted to only install this program on one's own personal computer using the installer provided by Mitsubishi, and the program shall not be used in a separate form.

■Article 6 (License Period, etc.)

This license shall be governed by and construed in accordance with the laws of Japan, and will remain effective from the point in which the customer commences the use of this software in accordance with this license until terminated by either of the events stated below.

- (1) The customer is entitled to terminate the License and invalidate the right granted according to this license within one (1) month after giving written notice to Mitsubishi.
- (2) Mitsubishi is entitled to terminate the License and invalidate the right granted to the customer according to this license immediately without notice if the customer fails to comply with any clause within this license.
- (3) Even in the event that the license is terminated by any of the previous clauses stated above, all clauses within Article 2 shall remain in full force and effect.

■Article 7 (Exportation)

Unless approved by Mitsubishi in advanced with written permission and by the country it is being exported to, the customer is prohibited from exporting or transferring the software directly or indirectly to countries outside the territory of the country where the software is provided.

■Article 8 (Termination)

In the event the rights granted in accordance with this License is invalidated for any reason, the customer shall immediately disable and cease using this software, all copies of this software, and any related documentation, etc. Additionally, the customer shall be obligated to submit a document, which proves the fact that all copies of this software have been destroyed, within four (4) weeks after the termination date. Furthermore, the customer is entirely responsible for the cost of returns and destruction of the software.

INDEX

B

Buffer memory 12

C

CAN 12

CANopen 12

CPU module STOP transition message 17

D

Device 12

E

EMCY 17

Engineering tool 12

External dimensions 15

G

Global label 12

H

Heartbeat 17

I

Intelligent function module 12

Internal current consumption (5VDC) 15

L

Label 12

Layer 2 message transmission and receive 17

M

Module label 12

N

NMT 17

Node guarding 17

Number of occupied I/O points 15

O

Operation setting at error occurrence 17

P

PDO 17

S

SDO 17

SYNC 17

T

TIME 17

Transmission cable terminal block 23

W

Weight 15

MEMO

REVISIONS

*The manual number is given on the bottom left of the back cover.

Revision date	*Manual number	Description
July 2017	SH(NA)-081734ENG-A	First edition
September 2017	SH(NA)-081734ENG-B	■ Added or modified parts Section 5.2, 7.1, Appendix 2

Japanese manual number: SH-081733-B

This manual confers no industrial property rights of any other kind, nor does it confer any patent licenses. Mitsubishi Electric Corporation cannot be held responsible for any problems involving industrial property rights which may occur as a result of using the contents noted in this manual.

© 2017 MITSUBISHI ELECTRIC CORPORATION

WARRANTY

Please confirm the following product warranty details before using this product.

1. Gratis Warranty Term and Gratis Warranty Range

If any faults or defects (hereinafter "Failure") found to be the responsibility of Mitsubishi occurs during use of the product within the gratis warranty term, the product shall be repaired at no cost via the sales representative or Mitsubishi Service Company.

However, if repairs are required onsite at domestic or overseas location, expenses to send an engineer will be solely at the customer's discretion. Mitsubishi shall not be held responsible for any re-commissioning, maintenance, or testing on-site that involves replacement of the failed module.

[Gratis Warranty Term]

The gratis warranty term of the product shall be for one year after the date of purchase or delivery to a designated place. Note that after manufacture and shipment from Mitsubishi, the maximum distribution period shall be six (6) months, and the longest gratis warranty term after manufacturing shall be eighteen (18) months. The gratis warranty term of repair parts shall not exceed the gratis warranty term before repairs.

[Gratis Warranty Range]

- (1) The range shall be limited to normal use within the usage state, usage methods and usage environment, etc., which follow the conditions and precautions, etc., given in the instruction manual, user's manual and caution labels on the product.
- (2) Even within the gratis warranty term, repairs shall be charged for in the following cases.
 1. Failure occurring from inappropriate storage or handling, carelessness or negligence by the user. Failure caused by the user's hardware or software design.
 2. Failure caused by unapproved modifications, etc., to the product by the user.
 3. When the Mitsubishi product is assembled into a user's device, Failure that could have been avoided if functions or structures, judged as necessary in the legal safety measures the user's device is subject to or as necessary by industry standards, had been provided.
 4. Failure that could have been avoided if consumable parts (battery, backlight, fuse, etc.) designated in the instruction manual had been correctly serviced or replaced.
 5. Failure caused by external irresistible forces such as fires or abnormal voltages, and Failure caused by force majeure such as earthquakes, lightning, wind and water damage.
 6. Failure caused by reasons unpredictable by scientific technology standards at time of shipment from Mitsubishi.
 7. Any other failure found not to be the responsibility of Mitsubishi or that admitted not to be so by the user.

2. Onerous repair term after discontinuation of production

- (1) Mitsubishi shall accept onerous product repairs for seven (7) years after production of the product is discontinued. Discontinuation of production shall be notified with Mitsubishi Technical Bulletins, etc.
- (2) Product supply (including repair parts) is not available after production is discontinued.

3. Overseas service

Overseas, repairs shall be accepted by Mitsubishi's local overseas FA Center. Note that the repair conditions at each FA Center may differ.

4. Exclusion of loss in opportunity and secondary loss from warranty liability

Regardless of the gratis warranty term, Mitsubishi shall not be liable for compensation to:

- (1) Damages caused by any cause found not to be the responsibility of Mitsubishi.
- (2) Loss in opportunity, lost profits incurred to the user by Failures of Mitsubishi products.
- (3) Special damages and secondary damages whether foreseeable or not, compensation for accidents, and compensation for damages to products other than Mitsubishi products.
- (4) Replacement by the user, maintenance of on-site equipment, start-up test run and other tasks.

5. Changes in product specifications

The specifications given in the catalogs, manuals or technical documents are subject to change without prior notice.

TRADEMARKS

CiA[®] and CANopen[®] are registered Community Trademarks of CAN in Automation e.V.

Ethernet is a registered trademark of Fuji Xerox Co., Ltd. in Japan.

The company names, system names and product names mentioned in this manual are either registered trademarks or trademarks of their respective companies.

In some cases, trademark symbols such as [™] or [®] are not specified in this manual.

SH(NA)-081734ENG-B(1709)MEE

MODEL: RJ71CN91-U-IN-E

MODEL CODE: 13JX70

mitsubishi electric corporation

HEAD OFFICE : TOKYO BUILDING, 2-7-3 MARUNOUCHI, CHIYODA-KU, TOKYO 100-8310, JAPAN
NAGOYA WORKS : 1-14, YADA-MINAMI 5-CHOME, HIGASHI-KU, NAGOYA, JAPAN

When exported from Japan, this manual does not require application to the
Ministry of Economy, Trade and Industry for service transaction permission.

Specifications subject to change without notice.